

Performance Data

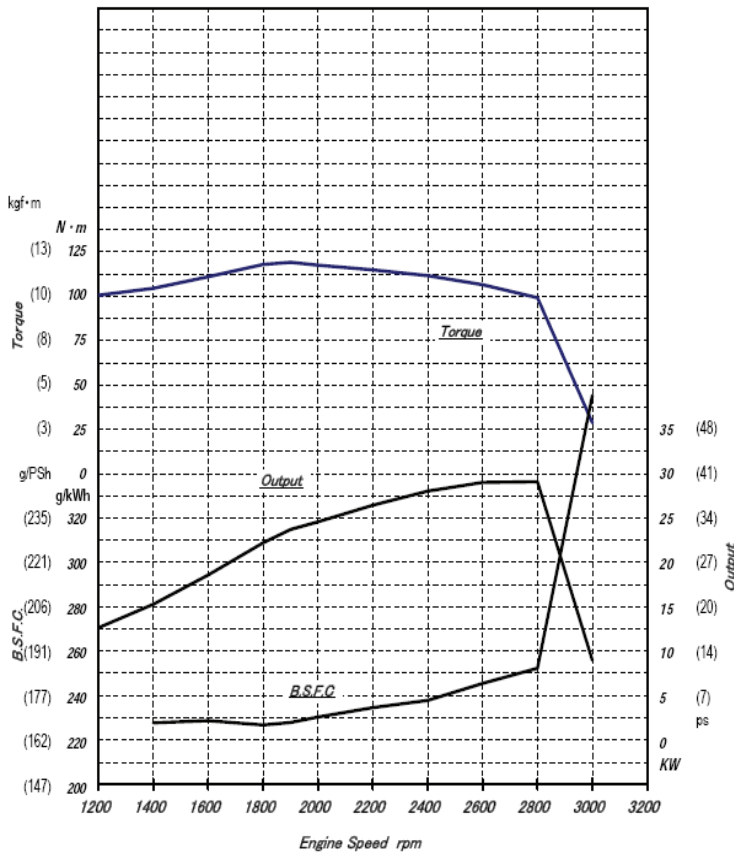

kW to Hp conversion used is expressed as: $HP = (kW \text{ value}) \times 1.34$

Rated Speed (rpm)	Net rated kW	Net rated HP	Max. Torque (ft-lb)
2800	29.0	38.9	90.4 @ 1680 rpm

Ratings Definitions and Conditions

*Rated power listed is NET engine output. The engine operating environment and driven machine conditions must be studied carefully when selecting an engine in order to ensure correct engine selection, maximize engine performance, extend engine service life and improve machine capacity.

Consult the TNV Application Manual for additional engine ratings and engine application information.

Application standards for Yanmar industrial engines: Inlet air standard conditions with a total barometric pressure of 100kPa (29.5 in. Hg), with a vapor pressure of 1 kPa (.295 in. Hg), and 25°C (77°F).

Dimensions

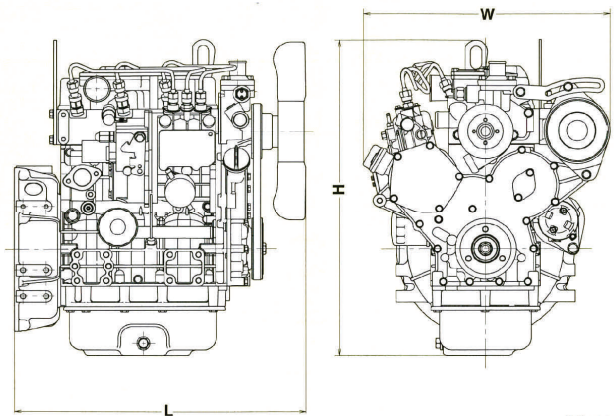

Length	24.0 in (610 mm)
Width	19.7 in (502 mm)
Height	27.5 in (699 mm)

Note: Dimensions depend on final specifications.

Materials and specifications herein are intended to serve as a guide in engine selection and subject to change without notice. The International System of Units (SI) is used in this publication. Yanmar and its logos, as well as corporate identity used herein, are trademarks of Yanmar and may not be used without permission.